

SECTION **HRN**
HORN

A
B
C
D
E
F
G
H
I
J
K
M
N
O
P

CONTENTS

PRECAUTION	2	COMPONENT DIAGNOSIS	4
PRECAUTIONS	2	HORN	4
Precaution for Supplemental Restraint System (SRS) "AIR BAG" and "SEAT BELT PRE-TENSIONER"	2	Wiring Diagram	4
Precautions Necessary for Steering Wheel Rotation after Battery Disconnect (Early Production, With Electronic Steering Column Lock)	2	ON-VEHICLE REPAIR	8
		HORN	8
		Removal and Installation	8

HRN

PRECAUTIONS

< PRECAUTION >

PRECAUTION

PRECAUTIONS

Precaution for Supplemental Restraint System (SRS) "AIR BAG" and "SEAT BELT PRE-TENSIONER"

INFOID:000000005461134

The Supplemental Restraint System such as "AIR BAG" and "SEAT BELT PRE-TENSIONER", used along with a front seat belt, helps to reduce the risk or severity of injury to the driver and front passenger for certain types of collision. This system includes seat belt switch inputs and dual stage front air bag modules. The SRS system uses the seat belt switches to determine the front air bag deployment, and may only deploy one front air bag, depending on the severity of a collision and whether the front occupants are belted or unbelted. Information necessary to service the system safely is included in the SR and SB section of this Service Manual.

WARNING:

- To avoid rendering the SRS inoperative, which could increase the risk of personal injury or death in the event of a collision which would result in air bag inflation, all maintenance must be performed by an authorized NISSAN/INFINITI dealer.
- Improper maintenance, including incorrect removal and installation of the SRS, can lead to personal injury caused by unintentional activation of the system. For removal of Spiral Cable and Air Bag Module, see the SR section.
- Do not use electrical test equipment on any circuit related to the SRS unless instructed to in this Service Manual. SRS wiring harnesses can be identified by yellow and/or orange harnesses or harness connectors.

PRECAUTIONS WHEN USING POWER TOOLS (AIR OR ELECTRIC) AND HAMMERS

WARNING:

- When working near the Airbag Diagnosis Sensor Unit or other Airbag System sensors with the Ignition ON or engine running, DO NOT use air or electric power tools or strike near the sensor(s) with a hammer. Heavy vibration could activate the sensor(s) and deploy the air bag(s), possibly causing serious injury.
- When using air or electric power tools or hammers, always switch the Ignition OFF, disconnect the battery, and wait at least 3 minutes before performing any service.

Precautions Necessary for Steering Wheel Rotation after Battery Disconnect (Early Production, With Electronic Steering Column Lock)

INFOID:000000005885959

NOTE:

- Before removing and installing any control units, first turn the push-button ignition switch to the LOCK position, then disconnect both battery cables.
- After finishing work, confirm that all control unit connectors are connected properly, then re-connect both battery cables.
- Always use CONSULT-III to perform self-diagnosis as a part of each function inspection after finishing work. If a DTC is detected, perform trouble diagnosis according to self-diagnosis results.

This vehicle is equipped with a push-button ignition switch and a steering lock unit.

If the battery is disconnected or discharged, the steering wheel will lock and cannot be turned.

If turning the steering wheel is required with the battery disconnected or discharged, follow the procedure below before starting the repair operation.

OPERATION PROCEDURE

1. Connect both battery cables.

NOTE:

Supply power using jumper cables if battery is discharged.

2. Carry the Intelligent Key or insert it to the key slot and turn the push-button ignition switch to ACC position. (At this time, the steering lock will be released.)
3. Disconnect both battery cables. The steering lock will remain released with both battery cables disconnected and the steering wheel can be turned.
4. Perform the necessary repair operation.

PRECAUTIONS

< PRECAUTION >

5. When the repair work is completed, re-connect both battery cables. With the brake pedal released, turn the push-button ignition switch from ACC position to ON position, then to LOCK position. (The steering wheel will lock when the push-button ignition switch is turned to LOCK position.)
6. Perform self-diagnosis check of all control units using CONSULT-III.

A

B

C

D

E

F

G

H

I

J

K

HRN

M

N

O

P

HORN

< COMPONENT DIAGNOSIS >

COMPONENT DIAGNOSIS

HORN

Wiring Diagram

INFOID:000000005461136

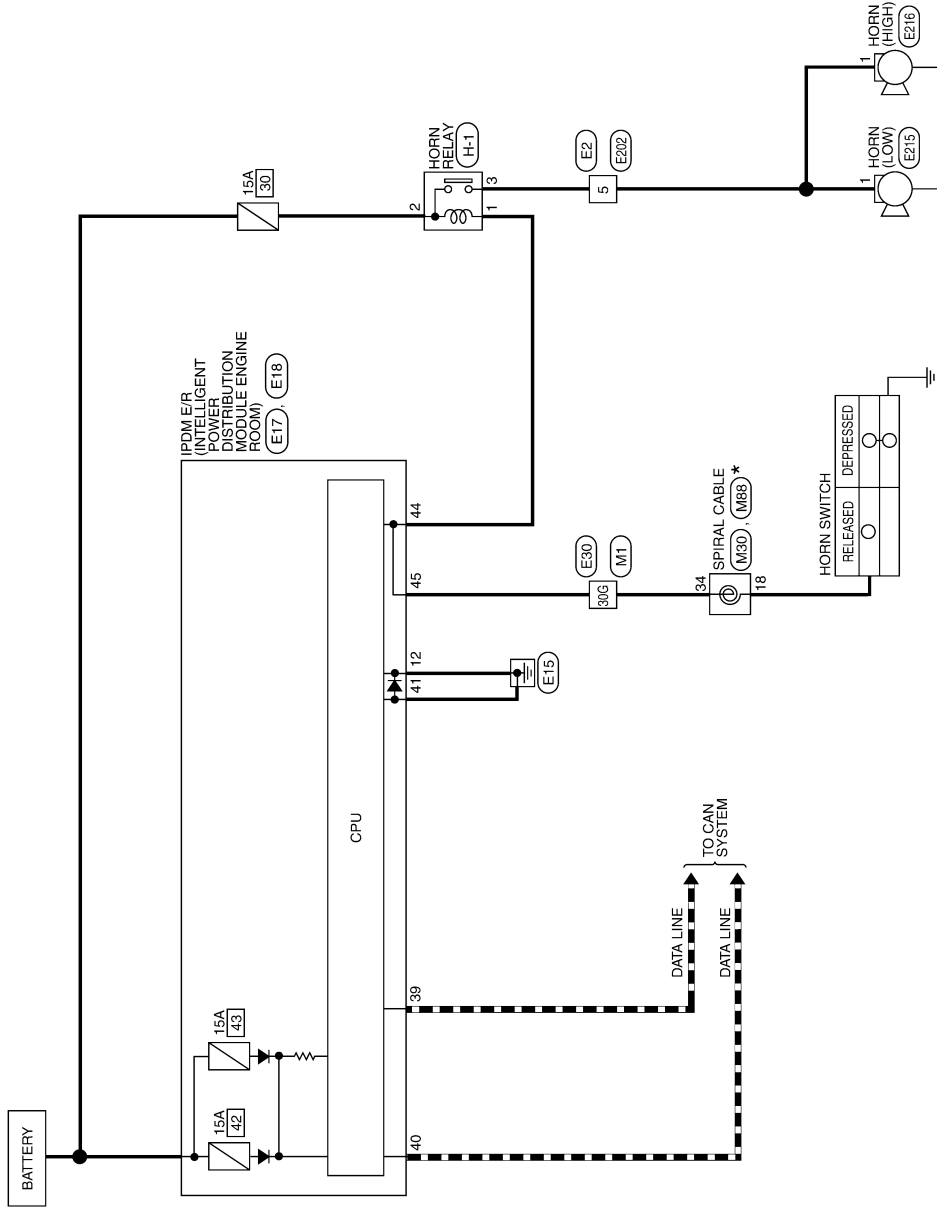

* : THIS CONNECTOR IS NOT SHOWN IN "HARNES LAYOUT" OF PG SECTION.

ABLWA0569GE

HORN

HORN

< COMPONENT DIAGNOSIS >

HORN CONNECTORS

Connector No.	M1
Connector Name	WIRE TO WIRE
Connector Color	WHITE

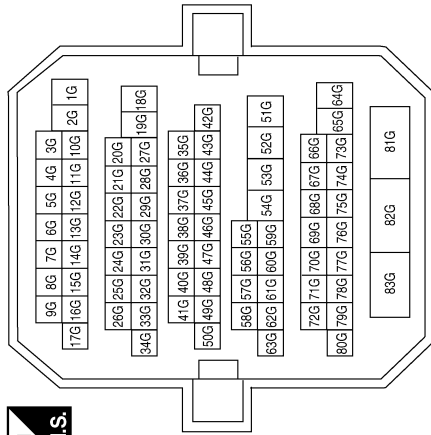

Terminal No.	Color of Wire	Signal Name
30G	L/W	-

Connector No.	M30
Connector Name	SPIRAL CABLE
Connector Color	GRAY

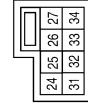

Terminal No.	Color of Wire	Signal Name
34	L/W	HORN

Connector No.	M88
Connector Name	SPIRAL CABLE
Connector Color	GRAY



Connector No.	E2
Connector Name	WIRE TO WIRE
Connector Color	WHITE



Terminal No.	Color of Wire	Signal Name
18	G	HORN

Connector No.	E17
Connector Name	IPDM E/R (INTELLIGENT POWER DISTRIBUTION MODULE ENGINE ROOM)
Connector Color	WHITE

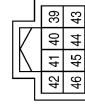

Terminal No.	Color of Wire	Signal Name
39	P	CAN-L
40	L	CAN-H
41	B	GND (SIGNAL)
44	W	HORN RLY
45	GR	HORN SW

ABLIA1729GB

HORN

< COMPONENT DIAGNOSIS >

Terminal No.	Color of Wire	Signal Name
30G	GR	-

Connector No.	E30
Connector Name	WIRE TO WIRE
Connector Color	WHITE

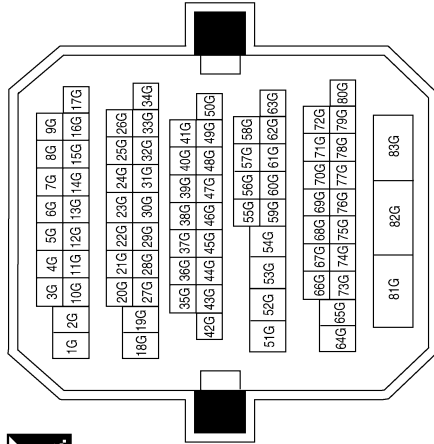

Connector No.	E18
Connector Name	IPDM E/R (INTELLIGENT POWER DISTRIBUTION MODULE ENGINE ROOM)
Connector Color	WHITE

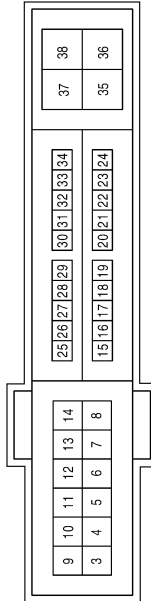

Terminal No.	Color of Wire	Signal Name
12	B	GND (POWER)

Connector No.	E216
Connector Name	HORN (HIGH)
Connector Color	BLACK



Connector No.	E215
Connector Name	HORN (LOW)
Connector Color	BLACK



Connector No.	E202
Connector Name	WIRE TO WIRE
Connector Color	WHITE



Terminal No.	Color of Wire	Signal Name
1	G	-

Terminal No.	Color of Wire	Signal Name
1	G	-

Terminal No.	Color of Wire	Signal Name
5	G	-

ABLIA1730GB

HORN

< COMPONENT DIAGNOSIS >

A
B
C
D
E
F
G
H
I
J
K
M
N
O
P

Connector No.	H-1
Connector Name	FUSE AND FUSIBLE LINK BOX (HORN RELAY)
Connector Color	-

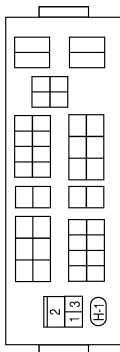

Terminal No.	Color of Wire	Signal Name
1	W	-
2	SB	-
3	O	-

HRN

ABLIA1731GB

HORN

< ON-VEHICLE REPAIR >

ON-VEHICLE REPAIR

HORN

Removal and Installation

INFOID:000000005461137

REMOVAL

1. Remove the engine side cover. Refer to [EXT-13. "Exploded View"](#).
2. Position aside the front fender protector LH. Refer to [EXT-20. "Removal and Installation"](#).
3. Disconnect the horn connectors (A).
4. Remove the horn bracket bolt (B), and remove horn (1) and horn (2).

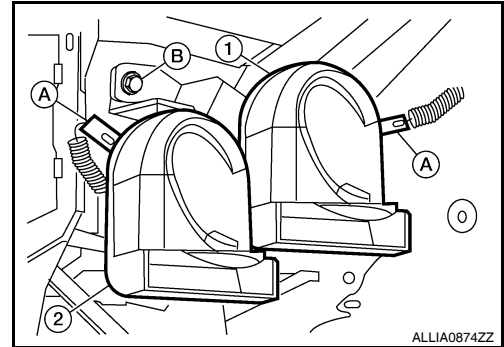

INSTALLATION

Installation is in the reverse order of removal.